



8000EN WINCH OWNERS MANUAL

WINCH MODELS:

80ENS24, 80ENA24, 80LDS24

ENGLISH



Doc-rev 20230420

SAVE THESE INSTRUCTIONS. This manual contains important safety precautions which should be read and understood before operating the product. Failure to do so could result in serious injury. Specifications, descriptions and images in this manual are as accurate as known at the time of publication, but are subject to change without notice.

INTRODUCTION

Congratulations on your purchase of a winch. We design and build winches to strict specifications and with proper use and maintenance your winch should bring you years of satisfying service.

Every effort has been made to ensure the accuracy and completeness of the information in this manual at the time of publication, and we reserve the right to change, alter and/or improve the product and this document at any time without prior notice.

SAFETY DEFINITIONS

Your winch can develop tremendous pulling forces and if used unsafely or improperly could result in property damage, serious injury or death. Throughout this manual, you will find the following symbols for caution, warning and danger. Pay particular attention to the notes preceded by these symbols as they are written for your safety. Ultimately, safe operation of this device rests with you, the operator.

DANGER

DANGER indicates a hazardous situation which, if not avoided, will result in death or serious injury.

WARNING

WARNING indicates a hazardous situation which, if not avoided, could result in death or serious injury.

CAUTION

CAUTION indicates a hazardous situation which, if not avoided, could result in minor or moderate injury.

NOTICE

NOTICE indicates information considered important, but not hazard-related (e.g., messages relating to property damage).

GETTING TO KNOW YOUR WINCH

Your winch is a powerful piece of machinery. It is important that you understand the basics of its operation and specifications so that when you need to use it, you can use it with confidence and safety. Below is a list of the components of your winch and their uses.

1. This winch is engineered for maximum line pull with only one layer of cable spooled onto the winch drum (the first layer).
2. Motor: The motor is powered by a 12/24-volt battery and provides power to the gear assembly which turns the drum and winds the wire rope in a direction.
3. Winch Drum: The winch drum is the cylinder on which the wire rope is stored. It can be spooled In or Out by use of the remote lead switch.
4. Wire Rope: Your winch has a galvanized aircraft cable designed specifically for load capacity of the rated line pull of this winch. The wire rope feeds on from underneath the drum position, it is looped at one end to accept the hook.
5. Fairlead: For when using the winch at an angle the roller fairlead acts to guide the rope onto the drum evenly and minimizes damage to the rope or winch from abrasion.
6. Gear Assembly System: The reduction gears convert the winch motor power into extreme pulling forces.
7. Braking System: Braking action is automatically applied to the winch when the winch motor is stopped or there is a load on the wire rope. This is achieved by a separate external mechanical brake which applies the braking action. (Brakes are NOT designed as securing devices and the winch cables should never be left attached when vehicle / equipment is in transport).
8. Free Spooling Clutch: The clutch allows the operator to manually disengage ("CLUTCH OUT") the spooling drum from the gear train. This is called free spool. Engaging the clutch ("CLUTCH IN") locks the winch into the gear system.
9. Solenoid: Power from the vehicle battery flows through the weatherproof switch before being directed to the winch motor.
10. Wired Remote lead Switch: The remote switch leads have a dual switch for powering in or powering out your winch drum. The remote control allows you to stand clear of the wire rope when the winch is under load.
11. Wireless remote (Not included): This is designed and offered for 'Offroad' or 'None Commercial' use only and is not included in any warranty offered. This allows the operator to always control the winch from up to 50 Ft away.
12. Universal Flat Bed Mounting Channel: (Optional) Your winch could have been optionally supplied with a flat bed mounting channel that can be mounted to most flat surfaces such as trailers, truck beds and structures etc. The mounting channel also has a number of mounting holes and holes to accept your roller fairlead.
13. Pulley/Snatch Block: (Optional) If your winch is supplied with a pulley/snatch block which can double the pulling power of the winch, or change the pulling direction without damaging the wire rope. We recommend you to use a double line and snatch block for pulling over 70% of the rated line pull.

IMPORTANT SAFETY INSTRUCTIONS

DANGER

DO NOT EXCEED RATED CAPACITY.

INTERMITTENT USE ONLY - COOL BETWEEN USES.

DO NOT use winch for lifting/moving people or live animals.

A minimum of five wraps of cable around the drum barrel is necessary for pulling and holding the rated load. The cable clamp is not designed to hold the load without the 5 wraps of cable around the drum. (usually marked red on the drum end of the cable)

DANGER

Keep yourself and others a **SAFE DISTANCE** to the side of the cable when under tension.

NEVER stand or step over a cable, or near a cable under load using a winch blanket or sail is strongly recommended.

DON'T move the vehicle to pull a load (towing) on the winch cable. This could result in cable breakage.

Disconnect the remote control and isolate when not in use

DANGER

DO NOT exceed maximum pull rating. Avoid “shock loading” by using the remote lead switch intermittently to take up the slack in the wire rope. “Shock loading” can far exceed the rated capacity for the wire rope and drum and will result in damaging winch and brake. By doing so will void any warranty.

DANGER

DO NOT use you winch as securing device it is not designed for this and will result in damaging winch and brake and will void any warranty.

DO NOT exceed maximum line pull ratings shown on the tables.

DO NOT use as a hoist. Do not use for overhead lifting.

DANGER

NEVER cut, weld, or modify any part of the winch or cable. By doing so will void any warranty

DANGER

When re-spooling the cable Ensure that the cable spools in the under-wind position with the cable entering the drum from the bottom, not the top. To re-spool correctly, and while wearing gloves, keep a slight tension on the cable while pushing the remote control button to draw in the cable. Walk toward the winch **NEVER** allowing the winch cable to slide through your fingers or hands.

DO NOT let your hands get within 12”(30cm) of the winch while re-spooling. Turn off the winch and repeat the procedure until a few feet of cable is left. Disconnect the remote control and finish spooling by hand by rotating the drum manually with the clutch disengaged. Keep hands clear of the fairlead and drum while the winch is under power.

DANGER

Failure to read and understand these warnings may result in personal injury and/or property damage.

Always use gloves to protect hands when handling any type of cable/rope. Never let the cable slide through your hands.

NEVER connect the cable back to itself.

Always apply blocks/chocks/straps to the wheels of the vehicle/equipment when on an incline and in transportation.

No modifications, alterations, or deviation to the winch are authorized by the manufacturer and **MUST NOT** be made. By doing so will void any warranty.

Duration of winching pulls should be kept as short as possible. If the motor becomes uncomfortably hot to the touch, stop winching immediately and let it cool down for approx 8 mins minutes. Do not winch for more than two minutes at or near the maximum rated load without resting for 8 minutes.

DANGER

If the motor stalls **DO NOT** maintain winching. Winches are designed and made for intermittent use and should be used in conjunction with their duty cycles.

NEVER release the free-spool clutch when there is a load on the winch as the load will roll backwards.

Use hand saver hook when handling the hook for spooling or unspooling the wire rope.

NOTICE

The winch and its all-derivative types are rated at rated capacity when spooling the first rope layer on the drum. Overloading can damage the winch / motor / or wire rope.

For loads over 70% of rated line pull, we recommend the use of the pulley block / snatch block to double the wire rope line and reduce the strain. This will aid in two ways:

It will reduce the number of rope layers on the drum and reduce the load on the wire rope by as much as 50%. When doubling the lineback to the vehicle, always attach to the frame or another load bearing point..

NOTICE

The vehicle engine should always be kept running during winching operation to minimize battery drain and maximize power and speed of the winch. If the winch is used for a considerable amount of time with the engine switched off the battery will drain and be too weak to restart the vehicle engine. If this happens stop winching immediately, jump start the vehicle and charge the battery up before resuming winching operation.

NOTICE

Get to know your winch before you need to use it. We recommend that you set up a few test runs to familiarize yourself with rigging techniques; the sounds your winch makes under various loads and the way the cable spools on the drum, etc.

INSPECT the wire rope and equipment before each use. A frayed or damaged rope must be replaced immediately. Use only manufacturer's identical replacement rope with the exact specifications. (Ropes are not covered by any warranty offered)

INSPECT the winch installation and bolts to ensure that all bolts are tight before each operation or periodically.

NOTICE

Store the remote control lead inside your vehicle or in a safe place.

Never connect the winch cable back to itself. This will cause cable to damage. Always use a pulley, snatch block, sling or chain of suitable strength as shown in the illustrations.

NOTICE

Any winch that appears to be faulty, damaged, worn, or operates abnormally **MUST BE REMOVED FROM SERVICE UNTIL REPAIRED, REPLACED OR OVERHAULED**. It is recommended that the necessary repairs **ARE** made by a manufacturer's authorized repair facility **ONLY**.

NOTICE

Pull only on areas of the vehicle as specified by the vehicle manufacturer.

- Only accessories, attachments and/or adapters supplied by the manufacturer shall be used.

CAUTION

When using the tool, basic safety precautions should always be followed to reduce the risk of personal injury and damage to the equipment. Read all these instructions before using this tool!

WARNING

Keep children away. Children must never be allowed in the work area. Do not let them handle machines, tools, extension cords or operate this tool.

WARNING

Store idle equipment. When not in use, tools must be stored in a dry location to inhibit rust. Always lock up tools and keep out of reach of children.

CAUTION

Dress properly. Do not wear loose clothing or jewelry as they can be caught in moving parts. Protective, electrically non-conductive clothes and non-skid footwear are recommended when working. Wear restrictive hair covering to contain long hair.

WARNING

Use eye and ear protection. Always wear impact safety goggles. Wear a full-face shield if you are producing metal filings or wood chips. Wear a dust mask or respirator when working around metal, wood, and chemical dusts, and mists.

CAUTION

Maintain this winch with care. Keep this tool dry and clean for better and safer performance. Follow instructions for lubricating and changing accessories. Inspect winch rope periodically and, if damaged, have them replaced immediately by an authorized technician. The handles must be kept clean, dry, and free from oil and grease always.

Disconnect or unplug remote switch when not in use.

DANGER

Stay alert, watch what you are doing, use common sense. Do not operate any tool when you are tired.

WARNING

Check for damaged parts. Before using this winch, any parts that appear worn or damaged should be carefully checked to determine that it will operate properly and perform to its intended function. Check for damage including alignments, binding of moving parts; mounting fixtures. Any part that is damaged should be properly repaired or replaced by a qualified person. Do not use the tool if any switch does not turn "On" and "Off" properly.

WARNING

Replacement parts and accessories. When repairing or servicing, only use identical replacement parts. The use of any other parts will void the warranty.

⚠ WARNING

Do not operate tool if under the influence of alcohol or drugs. Read warning labels on prescription to determine if your judgment or reflexes are impaired while taking drugs. If there is any doubt, do not operate the tool.

⚠ DANGER

Keep hands and body away from Fairlead (cable intake slot) when operating.

Always secure vehicle in position before using winch.

⚠ WARNING

Be certain the winch is properly bolted to a structure (or vehicle) that can hold the winches maximum rated load.

Do not use inappropriate attachments to extend the length of the winch cable.

⚠ DANGER

Never lift people or hoist loads over people or lift live animals.

Never come in between the winch and the load when operating.

⚠ WARNING

Do not apply any loads to the winch when cable is fully extended past the safety mark. Keep at least 5 full wraps of cable on the spool, (Usually marked red on the winch cable at the drum end.)

After moving any piece of equipment with the winch, secure the equipment in place. Do not rely on the winch to hold for an extended period of time nor whilst in transport, winches are not securing device, By doing so will void any warranty

⚠ CAUTION

Examine winch before using. Components may be affected by exposure to chemicals, salts, and rust.

Do not cross over or go underneath winch cable when under load.

Use gloves while handling cable.

⚠ WARNING

Never operate winch if cable shows any signs of weakening, such as knotting or kinking. If it does you must replace immediately.

⚠ DANGER

Do not move your vehicle with the cable extended and attached to the load. You could easily exceed the winch rating and snap the cable.

When the vehicle is parked on an incline you should use wheel chocks.

⚠ CAUTION

Always re-spool cable neatly after any operation this will avoid any winch cable misalignment for the next use

⚠ CAUTION

The winch cable must be wound onto the drum under a load of at least 10% of the rated line pull or the outer wraps will draw into inner wraps and damage winch cable.

Before operating the winch under load you should check proper function of the winch by engaging and disengaging the clutch, by operating the directional controls, and operating the speed controls. This will ensure that the winch is working properly and will help prevent unintended damage and injury. Cycling the winch prior to loading will also ensure the gears are properly aligned.

⚠ CAUTION

Batteries contain gases which are flammable and explosive. Wear eye protection during installation and remove all jewelry. Do not lean over battery while making connections.

⚠ WARNING

It is **strongly recommended** a battery isolator is installed to protect vehicle, equipment and user from hazardous situations, if one isn't supplied it is recommended one is purchased and installed before operation of the winch.

Failure to install a battery isolator or safety cut off could result in damage to the vehicle, equipment and (or) operator and will result in voiding any warranty offered.

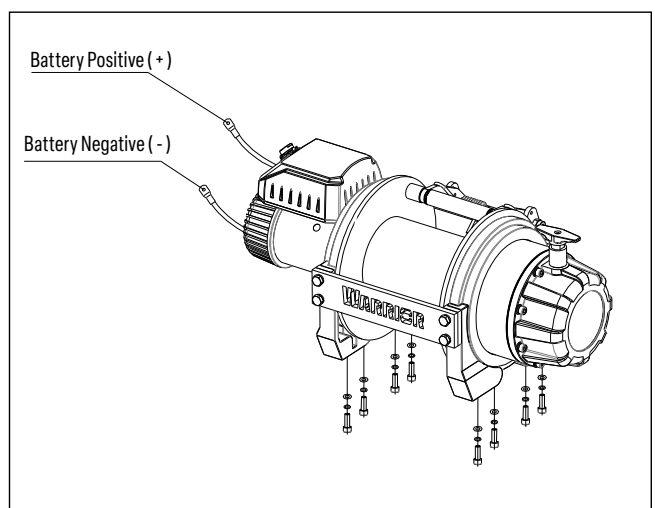
WINCH ASSEMBLY AND MOUNTING

Note: For illustration purpose only, winch can differ from diagram.

1. Your winch is designed with a bolt pattern that is standard in this class of winch. Many winch mounting kits are available that utilize this bolt pattern for the most popular vehicle and mounting channels. If you cannot find a kit locally, contact us and we will provide you with the name of a dealer near you. If you utilize the mounting channel, you must ensure that it is mounted on a flat surface so that the three major sections (motor, drum and gear housing) are properly aligned. Proper alignment of the winch will allow even distribution of the full rated load and reduce the chance of damaging winch or equipment. Poor installation contributes to approx 90% equipment or winch damage.
2. Start by connecting the Roller Fairlead to the Mounting Channel using 2 each of the Cap Bolt M10 X 35, Flat Washer, Lock Washer and securing with M10 Nut (Make sure the bolt is placed through the mounting channel and roller fairlead from inside the channel. This will allow enough clearance for the winch to be placed in the channel without obstruction.)
3. Assemble the winch to the (optional) Mounting Channel by first pulling and releasing the clutch knob to "Out" position (Free Spooling). Pull out a few inches of cable from the drum and feed the wire loop through the opening in the front of the mounting channel and roller fairlead. Now, using the remaining M10 x 35 Cap Bolts, Flat Washer, Lock Washer, and M10 Nut secure the winch to the mounting channel.
4. Connect the battery and motor leads as the drawing above. Remember every type of winch is different.
5. Connect the winch motor as detailed below:

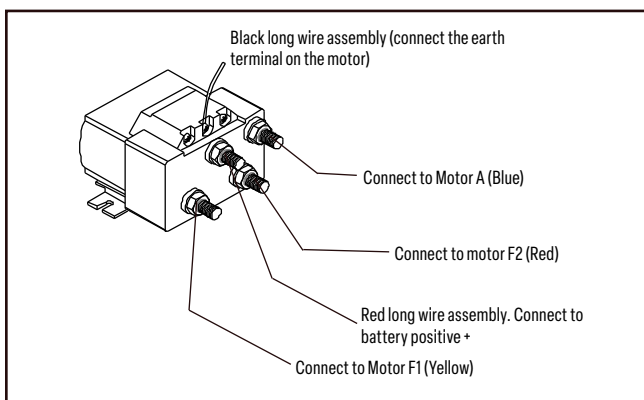
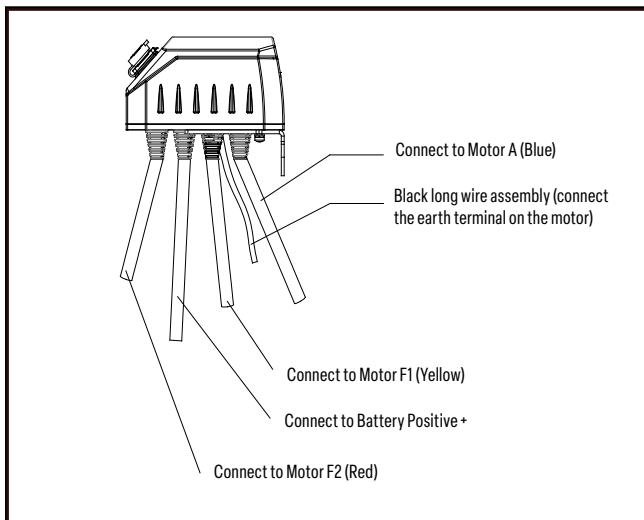
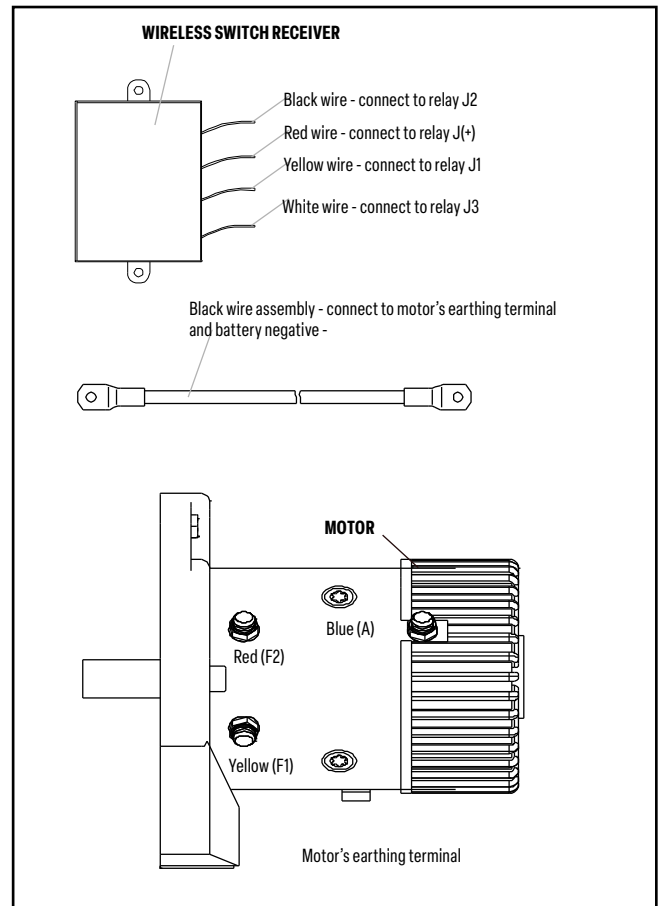

CAUTION

Batteries contain gases which are flammable and explosive. Wear eye protection during installation and remove all jewelry. Do not lean over battery while making connections.

6. Assemble the Clevis Hook to the cable. Take off the pin from the Clevis Hook, connect the Clevis Hook to the cable and mount the pin back to the Clevis Hook.
7. Always use the Hand Saver (Optional) when free-spooling and re-spooling the wire rope. Using the Hand Saver keeps your hands and fingers away from the rotating drum.
8. Check for proper drum rotation. Pull or turn the clutch knob to the "OUT" "Disengage" position (Free-spooling). Pull out some cable from the drum, and then turn the clutch knob to the "IN" "Engage" position to engage the gears. Press the cable out button on the remote lead switch. If the drum is turning and releasing cable, then your connections are accurate. If the drum is turning and collecting more cable, then reverse the leads on the motor. Repeat and check rotation.

RIGGING TECHNIQUES

Locate a suitable anchor such as a strong tree trunk or boulder.

ALWAYS use a sling or strap as an anchor point on a object, Never use the cable or hook as a anchor point attached to an object.

⚠ CAUTION

NEVER attach the clevis hook back onto the winch cable as this could cause damage to the cable.

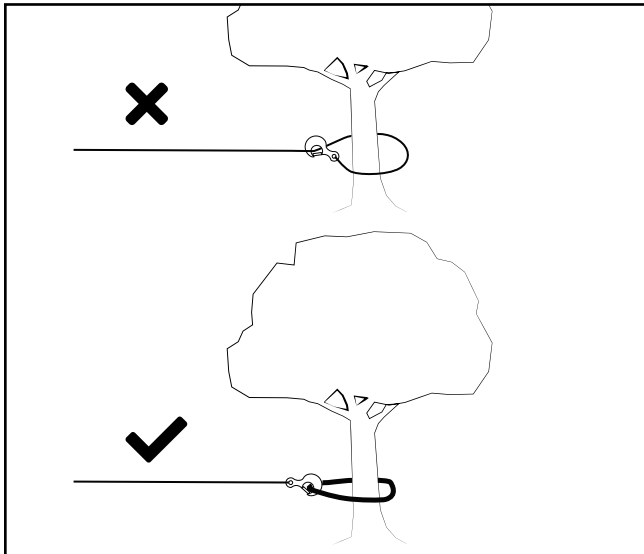

⚠ CAUTION

Do not winch from an acute angle as the wire rope will bind up on one side of the drum causing damage to wire rope (Bird Nesting) and cause major damage to winch and possible equipment.

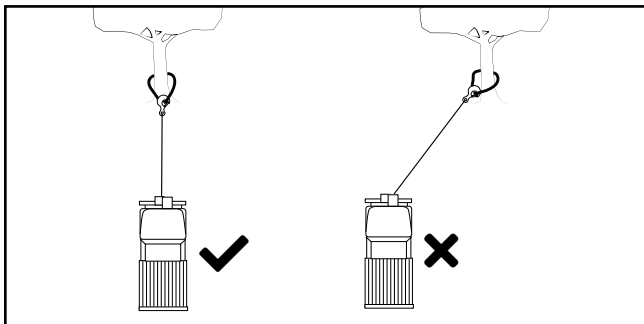

🗨 NOTICE

Short pulls from an angle can be used to straighten the vehicle/equipment. Long pulls should be done with the wire rope in a straight line to winch/vehicle, see above illustration.

⚠ CAUTION

When pulling a heavy load, place a blanket or jacket over the wire rope five or six feet from the hook because in the event of a broken cable it will dampen the force.

For additional protection open the hood/bonnet of the vehicle as shown.

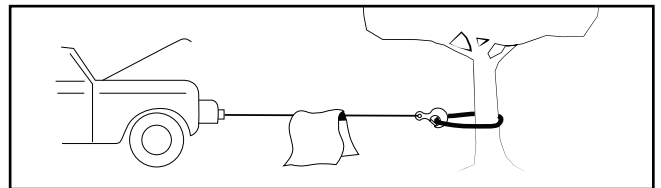

🗨 NOTICE

For pulls over 70% rated line pull, we recommend the use of the snatch/pulley block to double line the wire rope. This reduces the load on the winch and the strain on the rope.

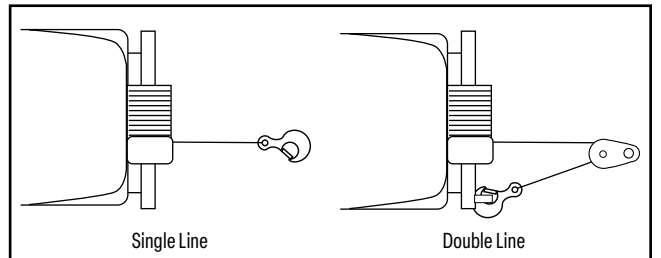

⚠ DANGER

Never use your winch for overhead hoisting, lifting of people, moving people or moving of live animals.

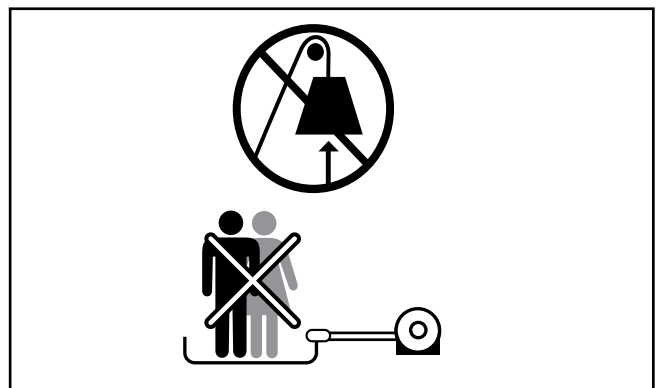

WINCHING TECHNIQUES A-Z

- a. Take time to assess your situation and plan your pull.
- b. Put on gloves to protect your hands.
- c. Disengage the clutch where possible to allow free-spooling and also save battery power.
- d. (If supplied) Attach the hand saver hook to the clevis hook.
- e. Pull out the wire rope to your desired anchor point safely.
- f. Secure the clevis hook to the anchor point: Sling, chain or snatch block. Do not attach the hook back onto the wire rope.
- g. Engage the clutch.
- h. Connect the remote control lead to the winch.
- i. Start your engine to ensure power is being replenished to the vehicle battery.
- j. Power in the wire rope guiding the wire under tension to draw up the slack in the wire. Once the wire is under tension stand well clear. Never stand or step over the wire rope under tension.
- k. Double check your anchors and make sure all connections are secure.
- l. Inspect the wire rope. Make sure there are at least 5 wraps of wire rope around the winch drum. (usually marked with red)
- m. Drape a blanket or sail (Sold separately) over the wire rope approximately 5 to 6 feet from the hook. Open the hood/bonnet for added protection.
- n. Clear the area. Make sure all people, spectators are well back and that no one is directly in front or behind the vehicle or anchor point.
- o. Begin winching. Be sure that the wire rope is winding evenly and tightly around the drum. If needed, the vehicle that is being winched can be slowly driven to add assistance to the winching process. Avoid shock loading; keep the wire rope under tension.
- p. The vehicle to be winched should be placed in neutral and the emergency brake released. Only release the brake pedal when under full tension. Avoid shock loading to the winch. This can damage the winch, rope and vehicle.
- q. The winch is meant for intermittent use. Under full load with a single line rig do not power in for more than 8 minutes without letting the motor cool down for a few minutes and then resume the winching operation.
- r. The winching operation is complete once the vehicle is on stable ground and or can drive under its own power.
- s. Secure the vehicle. Be sure to set the brakes and place the vehicle in park.
- t. Release the tension on the wire rope. The winch is NOT designed as securing device and should NEVER hold a load or secure whilst in transport, winch cable MUST be released when equipment or vehicle is secure. Not doing so will possibly damage the brake and winch and void any warranty.
- u. Disconnect the wire rope from the anchor and NEVER leave connected.
- v. Rewind the wire rope. Make sure that any wire already on the drum has spooled tightly and neatly. If not, draw out the wire and re-spool from the point where the rope is tight.
- w. Keep your hands clear of the winch drum and fairlead as the wire rope is being drawn in.
- x. Secure the hook and hook strap.

- y. Disconnect the remote control lead and store in a clean, dry place.
- z. Clean and inspect connections and mounting hardware for next winching operation.

Winch Working Demonstration

1. Disengage the clutch by turning the clutch to the "CLUTCH OUT" position.
2. Grab the cable assembly and pull the cable to the desired length, then attach to item being pulled.
3. Reengage the clutch by turn the clutch assembly to the "CLUTCH IN" position, rarely if ever the clutch is difficult to engage, you should slightly turn the drum by hand, and then turn the clutch.
4. Insert the switch assembly connector onto the control box
5. Test-run winch in two directions, each direction for one or two seconds.
6. While standing aside of the tow path, hold and operate the switch assembly supplied by your choice. To reverse directions. Wait until the motor stops before reversing directions.
7. When the pulling is complete, remove the switch assembly. From the female connector of the directional valve and replace the female connectors cover.

MAINTENANCE

1. Periodically check the tightness of mounting bolts and electrical connections. Remove all dirt or corrosion and always keep clean.
2. Do not attempt to disassemble the gear box. Repairs should be done by the manufacturer or an authorized repair center.
3. The gear box has been lubricated using a high temperature lithium grease and is sealed at the factory. No internal lubrication is required.

REPLACING THE WIRE ROPE

If the wire rope has become worn or is beginning to show signs of fraying, it must be replaced before being used again.

1. Turn the clutch to the "CLUTCH OUT" position.
2. Extend cable to its full length. Note how the existing cable is connected to the drum.
3. Remove old cable assembly and attach new one as the old cable connected to the drum. Insert the end of the new rope and secure the screw M8x10.
4. Ensure that the new cable wraps in the same rotation direction as the old one. The cable should exit the drum from the bottom, under the drum. (Underwind).
5. Turn the clutch to the "CLUTCH IN" position.
6. Winch cable onto drum, first five wraps being careful not to allow kinking, then winch cable must be wound onto the drum under a load of at least 10% rated line pull.

WARNING

Only replace the wire rope with the identical replacement part recommended by the manufacturer. Steel or synthetic ropes are NOT covered by any warranty offer and are sole responsibility of the owner or user to maintain and replace if necessary.

TROUBLESHOOTING

Problem	Cause	Solution
Motor does not turn on	Remote assembly not connected properly	Check remote lead and connections.
	Loose battery cable connections	Check battery and connections.
	Defective remote assembly	Replace remote lead assembly.
	Defective motor	Check for voltage at armature port with Switch pressed. If no voltage is present, replace motor.
	Water has entered motor	Allow to drain and dry. Run winch until completely dry.
Motor runs but drum does not turn	Clutch not engaged	Turn clutch to the "In" position. If problem persists, ask a technician to check and repair.
Motor runs slowly or without normal power	Insufficient current or voltage	Operate winch while vehicle motor running
Motor overheating	Winch running for too long	Allow winch to cool down periodically.
Motor runs in one direction only	Loose or corroded battery cable or motor cable connections.	- Clean and tighten. - Repair or replace switch assembly.
Winch braking malfunction	Cable runs in wrong direction	Adjust the cable working direction
	Brake slice worn or breakdown	Adjust braking angle or replaces with new brake slice

WARRANTY*

BPE Limited Ltd are the sole distributors of these WARRIOR WINCHES and associated brands/equipment.

BPE Limited ("seller" or BPE) warrants to the original retail buyer only ("Buyer") that any mechanical component of this genuine winch ("product(s)") are free of defects in material and workmanship for the lifetime of the winch.

The electrical components (including the motor, contactor, and switches) will be free of defects in material and workmanship for a period of (3) three years (36 Months) from the original purchase provable date of purchase

Any product BPE Limited determines to be defective will be repaired or replaced at our (BPE Limited) sole discretion without charge to the Buyer upon Buyer's compliance with this procedure. Seller or its Authorized Agent may make reasonable charges for parts and(or) labour for repairs not covered by this Lifetime Limited Warranty. None warrantable returns will be charged at BPE Limited standard rates. The warranties set forth herein are exclusive and in lieu of all other warranties, whether oral or written, express or implied.

If in the event your product becomes faulty within your warranty period

To obtain service or repair under this warranty, the Buyer shall mail, ship or otherwise deliver to the manufacturers address, at the Buyers expense; (1) the Product, (2) a written description of the problem, (3) Buyers name, address and contact number, (4) copy of the original purchase receipt or BPE Limited can arrange a suitable collection method (Charges apply).

Warranty Exclusions

The Warranty does not cover the cost of labour or transportation/shipping charges for the replacement or installation of defective part(s).

This warranty does not apply to defects of the Product caused by; (1) normal wear and tear, (2) failure to comply with any installation, maintenance or subjecting the product to loads in excess of the loads written/listed in the owners manual or as detailed upon the Sellers website, (3) alteration or modification by any parties other than the manufacturer, (4) misuse, abuse, neglect, accidents, Acts of God, terrorism or (5) failure to correctly use the item according to the owners manual (7) other causes beyond the control of the Seller after delivery of the Product to the Sellers Authorized Agent.

Other Exclusions

This Warranty does not cover steel cables, synthetic ropes, fairleads, wireless remotes or any exterior finishes outside thirty (30) Days from purchase.

BPE Limited shall not be responsible or liable for any indirect or consequential damages. These consequential damages may include, but are not limited to, lost profits or loss of use, down time or damage to other person(s) equipment.

BPE Limited reserves the right to change the Product design without notice. BPE Limited reserves the right to replace any part or whole unit with a newer design of the same function.

SPECIFICATIONS 80ENS24, 80ENA24

Rated line pulls	8000 kgs (17637 lbs)	
Gear reduction ratio	450:1	
Motor	24V:Input: 6.1kW / 8.2hp; Output: 3.1kW / 4.2hp	
Overall dimensions	25"×13.1"×11.6" 635 mm ×333mm ×294mm	
Drum size	Ø5.43 "×7.7 " (Ø138mm×196mm)	
Cable	Wire Rope	Synthetic rope
	Ø9/16"×87 ' (Ø13.8mm×26.5m)	Ø9/16"×92 ' (Ø14mm×28m)
Net Weight Lbs (kg)	220 Lbs (100.0 kg)	180 Lbs (82.0 kg)
Mounting bolt pattern	10 "×4.5 " (254mm×114.3 mm)	
	10 "×7.5 " (254mm×190.5mm)	

Pull, Speed, Amperes, Volts (First layer):

Line Pull	Line Speed ft/min (m/min)	Motor current Amps (Max)
lbs (kgs)	24V DC	24V DC
0	33.8 (10.3)	26
4409 (2000)	11.5 (3.5)	95
8818 (4000)	8.5 (2.6)	140
13228 (6000)	6.6 (2.0)	190
17637 (8000)	5.9 (1.8)	230

Line Pull And Rope Capacity In Layer

Layer	Rated line pull lbs (kgs)	Total rope on the drum ft (m)
1	17637 (8000)	18.7 (5.7)
2	14923 (6769)	42.7 (13)
3	12932 (5866)	70.2 (21.4)
4	11408 (5175)	92 (28)

WINCH ASSEMBLY DRAWING 80ENS24, 80ENA24

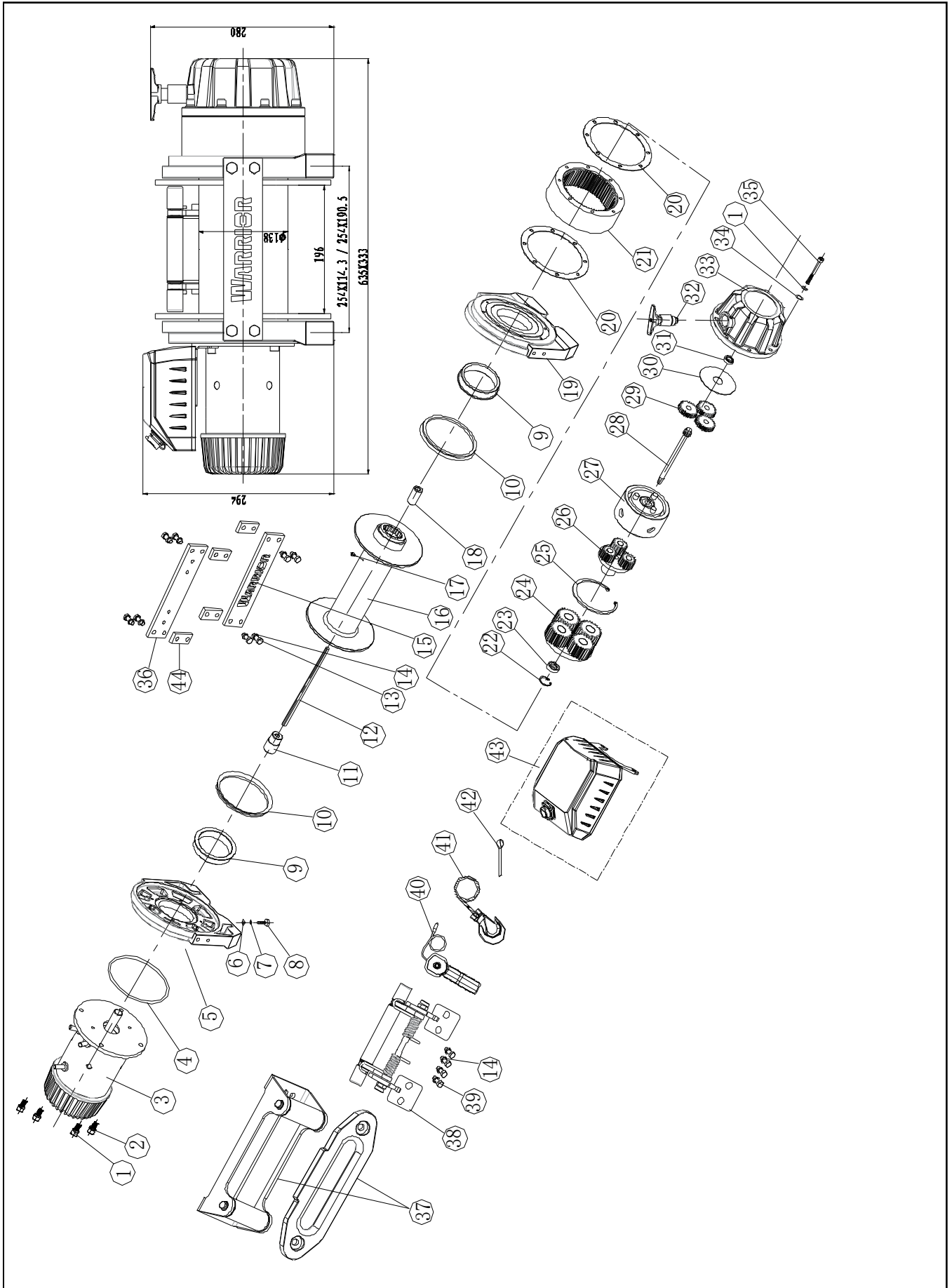

WINCH PARTS LIST (80ENS24, 80ENA24)

#	Part Number	Description	Qty.
1	80EN0001	Lock Washer Ø8	12
2	80EN0002	Screw M8x 25	4
3	80EN0100	Motor Assembly	1
4	80EN0003	Ring Seals	1
5	80EN0004	Motor Bracket	1
6	80EN0005	Flat Washer Ø12	8
7	80EN0006	Lock Washer Ø12	8
8	80EN0007	Cap Screw M12 x 30	8
9	80EN0008	Bushing-Drum	2
10	80EN0009	Ring Seals	2
11	80EN0010	Coupling	1
12	80EN0011	Six Angle Bar	1
13	80EN0012	Screw M10 x 25	8
14	80EN0013	Lock Washer Ø10	12
15	80EN0014	Tie Bar	1
16	80EN0200	Drum Assembly	1
17	80EN0015	Screw M8x10	2
18	80EN0016	Coupling	1
19	80EN0017	End Bearing	1
20	80EN0018	Gasket	2
21	80EN0019	Gear-Ring	1
22	80EN0020	Circlip For Hole	1
23	80EN0021	Bearing	1
24	80EN0300	Gear Carrier Assembly(Output)	1
25	80EN0022	Circlip For Hole	1
26	80EN0400	Gear Carrier Assembly(Intermediate)	1
27	80EN0500	Brake/ Shaft Assembly	1
28	80EN0023	Gear-Input Sun	1
29	80EN0024	Planetary Gear	3
30	80EN0025	Trust Washer	1
31	80EN0026	Bearing	1
32	80EN0600	Clutch Assembly	1
33	80EN0027	Gear-Housing	1
34	80EN0028	Flat Washer Ø8	8
35	80EN0029	Screw M8x 90	8
36	80EN0030	Tie Bar(I)	1

#	Part Number	Description	Qty.
37	80ENS0031	Roller Fairlead - 80ENS24	1
	80ENA0031	Aluminium Fairlead -80ENA24	1
38	80EN0700	Tensioned Of Steel Wire Supplied Assembly -80ENS24	1
39	80EN0032	Screw M10 x 20 - 80ENS24	4
40	80EN0033	Switch	1
41	80ENS0800	Cable Assembly - 80ENS24	1
	80ENA0800	Cable Assembly - 80ENA24	1
42	80EN0034	Strap	1
43	80EN0900	Control Section	1
44	80EN0035	Heel Block	4

SPECIFICATIONS 80LDS24

Rated line pulls	8000 kgs (17637 lbs)
Gear reduction ratio	450:1
Motor	24V: Input: 6.1kW / 8.2hp; Output: 3.1kW / 4.2hp
Overall dimensions	27"×13.1"×11.6" 685mm×333mm×294mm
Drum size	Ø5.43 "×9.76 " (Ø138mm×248mm)
Cable	Ø9/16"×131.2 ' (Ø13.8mm×40m)
Net Weight Lbs (Kg)	220 Lbs (100.0 kg)
Mounting bolt pattern	11.97 "×4.5 " (304mm×114.3 mm) 11.97 "×7.5 " (304mm×190.5mm)

Pull, Speed, Amperes, Volts (First layer):

Line Pull	Line Speed ft/min (m/min)	Motor current Amps (Max)
lbs (kgs)	24V DC	24V DC
0	33.8 (10.3)	26
4409 (2000)	11.5 (3.5)	95
8818 (4000)	8.5 (2.6)	140
13228 (6000)	6.6 (2.0)	190
17637 (8000)	5.9 (1.8)	230

Line Pull And Rope Capacity In Layer

Layer	Rated line pull lbs (kgs)	Total rope on the drum ft (m)
1	17637 (8000)	24.9(7.6)
2	14923 (6769)	55.8(17)
3	12932 (5866)	91.9(28)
4	11408 (5175)	131.2(40)

WINCH ASSEMBLY DRAWING 80LDS24

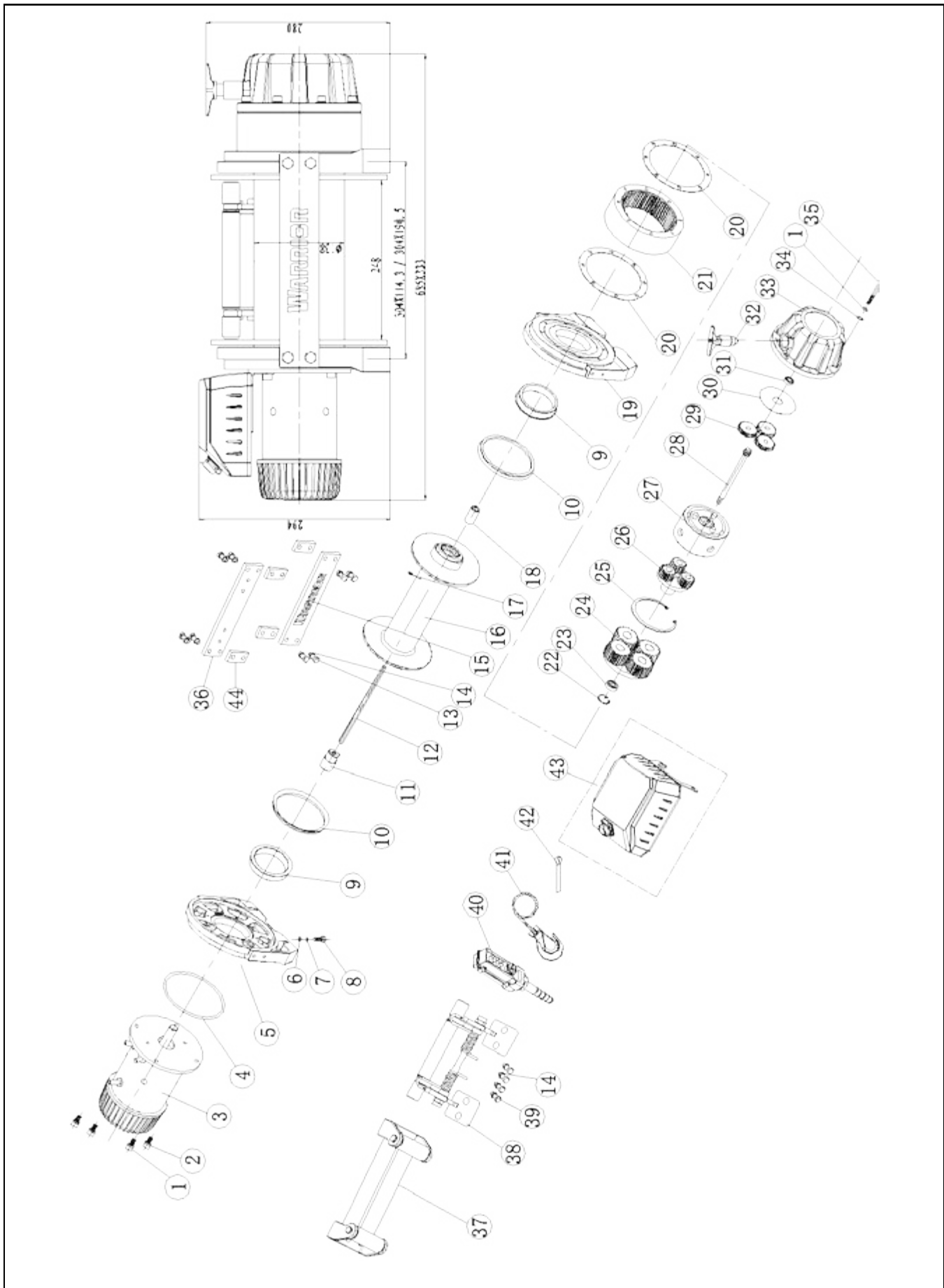

WINCH PARTS LIST (80LDS24)

#	Part Number	Description	Qty.
1	80LD0001	Lock Washer Ø8	12
2	80LD0002	Screw M8x 25	4
3	80LD0100	Motor Assembly	1
4	80LD0003	Ring Seals	1
5	80LD0004	Motor Bracket	1
6	80LD0005	Flat Washer Ø12	8
7	80LD0006	Lock Washer Ø12	8
8	80LD0007	Cap Screw M12 x 30	8
9	80LD0008	Bushing-Drum	2
10	80LD0009	Ring Seals	2
11	80LD0010	Coupling	1
12	80LD0011	Six Angle Bar	1
13	80LD0012	Screw M10 x 25	8
14	80LD0013	Lock Washer Ø10	12
15	80LD0014	Tie Bar	1
16	80LD0200	Drum Assembly	1
17	80LD0015	Screw M8x10	2
18	80LD0016	Coupling	1
19	80LD0017	End Bearing	1
20	80LD0018	Gasket	2
21	80LD0019	Gear-Ring	1
22	80LD0020	Circlip For Hole	1
23	80LD0021	Bearing	1
24	80LD0300	Gear Carrier Assembly (Output)	1
25	80LD0022	Circlip For Hole	1
26	80LD0400	Gear Carrier Assembly(Intermediate)	1
27	80LD0500	Brake/ Shaft Assembly	1
28	80LD0023	Gear-Input Sun	1
29	80LD0024	Planetary Gear	3
30	80LD0025	Trust Washer	1
31	80LD0026	Bearing	1
32	80LD0600	Clutch Assembly	1
33	80LD0027	Gear-Housing	1
34	80LD0028	Flat Washer Ø8	8
35	80LD0029	Screw M8x 90	8
36	80LD0030	Tie Bar(I)	1

#	Part Number	Description	Qty.
37	80LD0031	Roller Fairlead	1
38	80LD0700	Tensioned Of Steel Wire Supplied Assembly	1
39	80LD0032	Screw M10 x 20	4
40	80LD0033	Switch	1
41	80LD0800	Cable Assembly	1
42	80LD0034	Strap	1
43	80LD0900	Control Section	1
44	80LD0035	Heel Block	4

EC Declaration of Conformity

Zertifikatnr. / Certificat nr / Certificate No. MD-TCF220621-39334 -V4-BPE

Lieferant und Emittent / Fournisseur et émetteur / Supplier and Issuer:
BPE Solutions Deutschland GmbH, Alttrottstrasse 31, 69190 Walldorf, Deutschland

Gerät(e) / Dispositif (s) / Equipment	12V / 24V EN Samurai Electric Winch
Modell / Modéle / Model	25ENS12, 25ENS24, 40ENS12, 40ENS24, 52ENS12, 52ENS24, 60ENS12, 60ENS24, 80ENS12, 80ENS24, 80ENA12, 80ENA24
Seriennummer / numéro de série / Serial Number	

Gemäß den folgenden Richtlinien / Conformément aux directives suivantes
In accordance with the following directives :

Machinery Directive 2006/42/EC
Electromagnetic Compatibility Directive 2014/30/EU
RoHs Directive 2011/65/EU

Gemäß den folgenden Normen / Selon les normes suivantes /
In accordance with the following Standards:

BS EN 14492-1:2006+A1:2009	BS EN 60204-1:2018	BS EN IEC 61000-6-2:2019
BS EN IEC 61000-6-4:2019	BS EN ISO 12100:2010	BS EN ISO 3744:1995

Hiermit erkläre ich, dass das/die obengenannte(n) Gerät(e) gemäß den relevanten Abschnitten der obigen Anforderungen entworfen und hergestellt wurde(n). Die Produkte entsprechen den Grundanforderungen der relevanten Richtlinien und Normen. Dieses Zertifikat ist nur bei den obengenannten Produkten und Konfigurationen im Zusammenhang mit detaillierten Testdaten sowie mit allen zutreffenden rechtlichen Vorschriften des Produktes gültig.

Je déclare par la présente que le(s) dispositif(s) ci – dessus ont été conçus et fabriqués conformément aux sections pertinentes des exigences ci-dessus. Les produits satisfont aux exigences de base des directives et normes applicables. Ce certificat n'est valable que pour les produits et configurations ci-dessus en relation avec des données de test détaillées ainsi qu'avec toutes les réglementations légales applicables du produit.

I hereby declare that the equipment named above has been designed and manufactured to comply with relevant sections of the above referenced specifications. The products comply with the essential requirements of the relevant directives and standards. This certificate is only valid for the product(s) and configuration described in conjunction with details test data and with all applicable legal requirements of this product.

This declaration of conformity is issued under the exclusive responsibility of the manufacturer.

Datum / Date:	01.06.2022 09:52
Land / Pays / Issuing Country:	Deutschland

Paul Binson
QA & Development Manager



Registered Technical File Holders Address
BPE Solutions Deutschland GmbH
Alttrottstrasse 31
69190 Walldorf
Deutschland
DE 347460020

EC Declaration of Conformity

Certificate No. TEZJ22062139336-V7-BPE

Supplier and Issuer:

BPE Holdings Ltd, Unit 17/18A Bradley Hall Trad Est, Bradley Lane, Wigan, WN6 0XQ, UK

Equipment	12V, 24V EN Electric Winches
Model	25ENS12, 25ENS24, 40ENS12, 40ENS24, 52ENS12, 52ENS24, 60ENS12, 60ENS24, 80ENS12, 80ENS24, 80ENA12, 80ENA24
Serial Number	

In accordance with the following directives :

Machinery Directive 2006/42/EC
Electromagnetic Compatibility Directive 2014/30/EU

In accordance with the following Standards:

BS EN 14492-1:2006+A1:2009	BS EN 60204-1:2018	BS EN ISO 12100:2010
BS EN IEC 61000-6-2:2019	BS EN IEC 61000-4-2:2019	

I hereby declare that the equipment named above has been designed and manufactured to comply with relevant sections of the above referenced specifications. The products comply with the essential requirements of the relevant directives and standards. This certificate is only valid for the product(s) and configuration described in conjunction with details test data and with all applicable legal requirements of this product.

This declaration of conformity is issued under the exclusive responsibility of the manufacturer.

Date:	28.06.2022 11:52
Issuing Country:	United Kingdom

X P Bimson

Paul Bimson
QA & Development Manager

**UK
CA**

Registered Technical File Holder
BPE Holdings Ltd
Unit 17/18A Bradley Hall Trad Est
Bradley Lane
Wigan
WN6 0XQ
UK

**For warranty and repair enquiries, please
contact the retailer where you purchased
your winch product.**

Service & Technical Contacts

United Kingdom:

BPE Holdings
Unit 17-18
Bradley Hall Trading Estate
Bradley Lane, Standish
Wigan, WN6 0XQ, UK
service@bpeholdings.co.uk

Germany:

BPE Solutions Deutschland GmbH
Altrottstraße 31
D-69190 Walldorf
Germany
support@bpeholdings.de

France:

BPE Solutions France SAS
3 Boulevard de Belfort
59000 Lille
France
sav@bpeholdings.fr